

10 proizvodni program



ELIT
inox

SADRŽAJ:

	TALAS 8	3
	TALAS 10	4
	TALAS M/X/XX	5
	TALAS H	6
	TALAS K	7
	TALAS PODNI	8
	TALAS PODNI	9
	HIDROFORSKE POSUDE	10
	PROHROMSKI KAZANI	10
	HIDROPAK	10
	ELEKTRIČNI GREJAČ sa elektronskim termostatom	11

Talas 8

ELEKTRIČNI AKUMULACIONI ZAGREVAČI VODE otvorenog tipa serije TALAS 8



Tip 8V

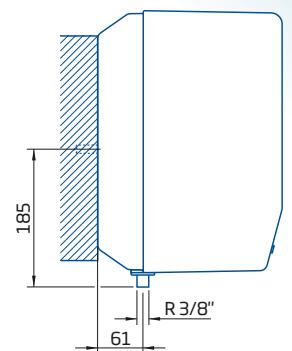
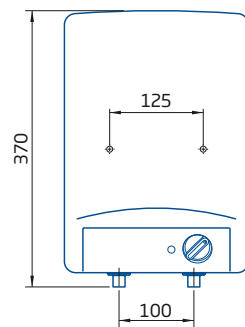

Tip 8N

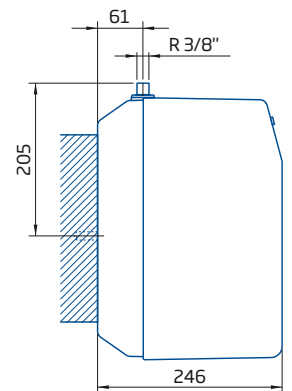
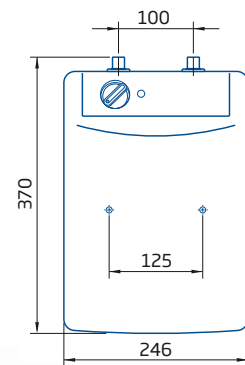

Tip	8V	8N
Zapremina	8	8
Tehničke karakteristike		
Materijal kazana	visokolegirani nerđajući čelik Č.4580 (prohrom)	
Radni pritisak (MPa)	0	
Toplotna izolacija	stiropor	
Raspon temp. regulacije	do 75° C	
Termostat	Regulacioni	
Termička zaštita	Termički osigurač	
Signalno svetlo	da	
Stepen zaštite	IP 24	
Električne karakteristike		
Snaga grejača (W)	1500	
Radni napon (V)	230	

elit
inox

Talas 10

**ELEKTRIČNI AKUMULACIONI
ZAGREVAČI VODE**
otvorenog tipa serije TALAS 10

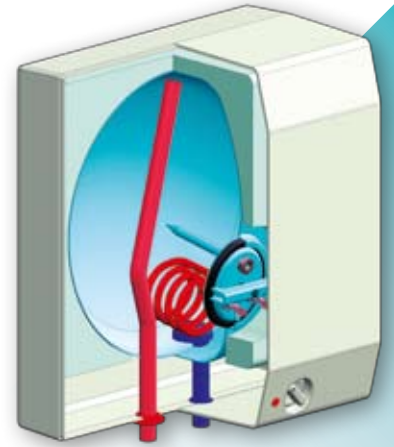

Tip 10V

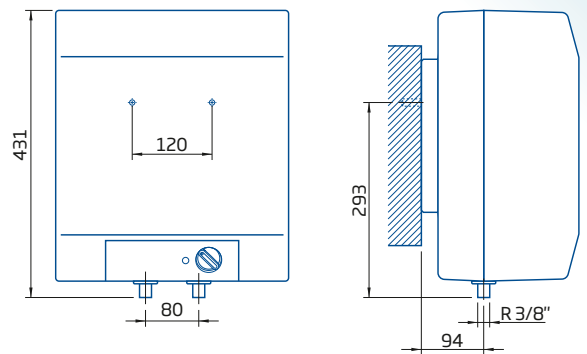

Tip 10N

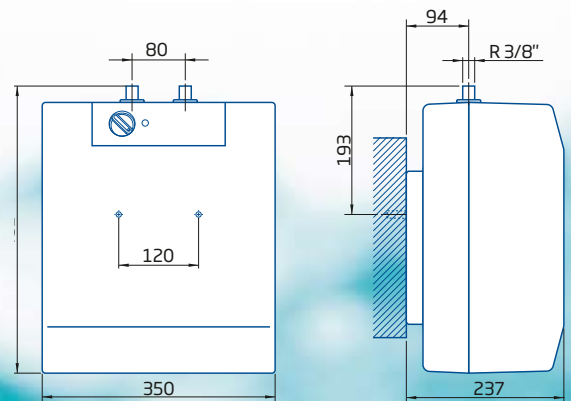

Tip	10V	10N
Zapremina	10	10
Tehničke karakteristike		
Materijal kazana	visokolegirani nerđajući čelik Č.4580 (prohrom)	
Radni pritisak (MPa)	0	
Toplotna izolacija	stiropor	
Raspon temp. regulacije	do 75° C	
Termostat	Regulacioni	
Termička zaštita	Termički osigurač	
Signalno svetlo	da	
Stepen zaštite	IP 24	
Električne karakteristike		
Snaga grejača (W)	1500	
Radni napon (V)	230	



TALAS M/X/XX

ELEKTRIČNI AKUMULACIONI ZAGREVAČI VODE
za vertikalnu ugradnju
serije TALAS M/X/XX



Talas M

Talas X

Talas XX

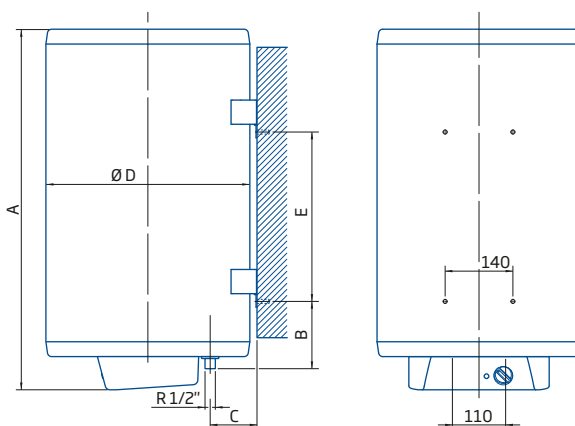

Tip	M30	M50	M60	M80	X50	X80	X100	XX80	XX100	XX120	XX150
Zapremina	30	50	60	80	50	80	100	80	100	120	150
Priključne mere											
A (mm)	480	750	815	995	620	880	1050	750	860	1050	1150
B (mm)	180	180	180	180	180	180	180	180	180	180	180
C (mm)	100	100	100	100	120	120	120	140	140	140	140
D (mm)	420	420	420	420	450	450	450	500	500	500	500
E (mm)	120	350	350	620	220	450	630	350	450	590	700
Tehničke karakteristike											
Materijal kazana	visokolegirani nerđajući čelik Č.4580 (prohrom)										
Radni pritisak (MPa)	0,6										
Mg zaštitna anoda	da										
Toplotna izolacija	Mineralna vuna sa aluminijumskom folijom										
Debljina izolacije	50 mm										
Raspon temp. regulacije	do 85° C										
Termostat	Regulacioni i zaštitni										
Signalno svetlo	da										
Sigurnosni ventil	da										
Broj zidnih nosača	2 kom										
Stepen zaštite	IP 24										
Električne karakteristike											
Snaga grejača (W)											3000
Radni napon (V)	230										

Talas H

**ELEKTRIČNI AKUMULACIONI
ZAGREVAČ VODE**
za horizontalnu ugradnju na zid

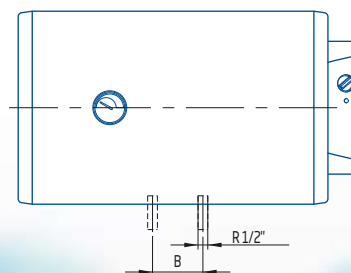
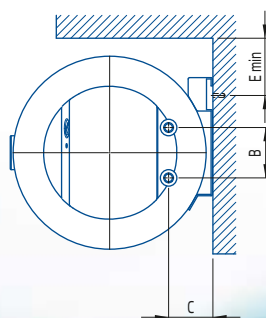
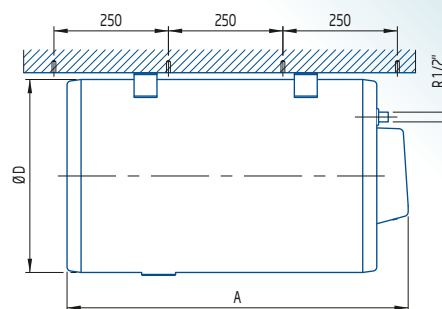
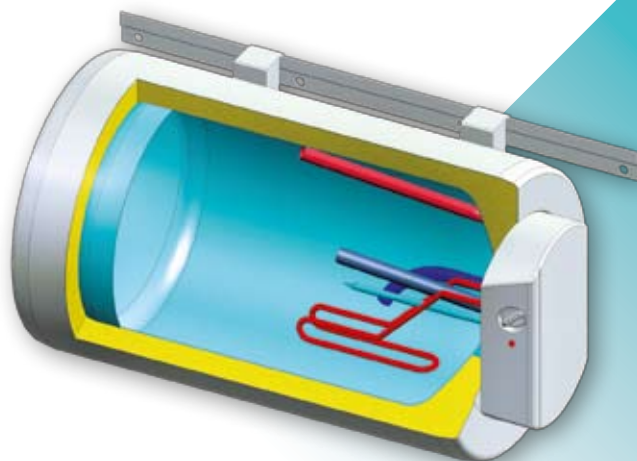

elit
inox

Tip	M50H	M60H	X80H	XX100H	XX120H
Zapremina	50	60	80	100	120
Priključne mere					
A (mm)	750	815	880	860	1050
B (mm)	110	110	110	110	110
C (mm)	100	100	120	140	140
D (mm)	420	420	450	500	500
E (mm)	185	185	185	200	200
Orijentacija priključaka	levo/desno/dole				
Tehničke karakteristike					
Materijal kazana	visokolegirani nerđajući čelik Č.4580 (prohrom)				
Radni pritisak (MPa)	0,6				
Mg zaštitna anoda	da				
Toplotna izolacija	Mineralna vuna sa aluminijumskom folijom				
Debljina izolacije	50 mm				
Raspon temp. regulacije	do 85° C				
Termostat	Regulacioni i zaštitni				
Signalno svetlo	da				
Sigurnosni ventil	da				
Stepen zaštite	IP 24				
Električne karakteristike					
Snaga grejača (W)	2000				
Radni napon (V)	230				

EDELSTAHL®
**Rost
frei**

Talask

KOMBINOVANI ELEKTRIČNI AKUMULACIONI ZAGREVAČ VODE za vertikalnu ugradnju na zid

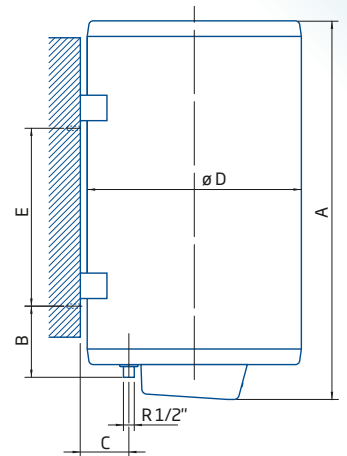
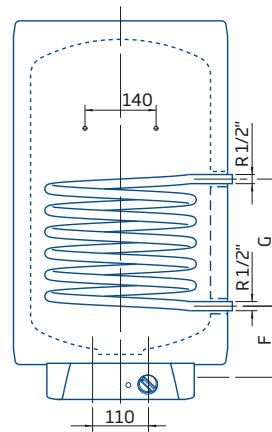
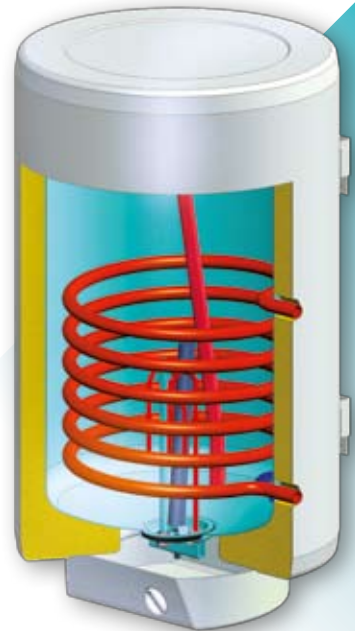

Tip	M50K	M60K	X80K Ø18	X80K Ø25	XX120K
Zapremina	50	60	80	80	120
Priključne mere					
A (mm)	750	815	880	880	1050
B (mm)	180	180	180	180	180
C (mm)	100	100	120	120	140
D (mm)	420	420	450	450	500
E (mm)	350	350	450	450	630
F (mm)	180	180	180	180	180
G (mm)	250	250	385	385	385
Orijentacija priključaka	levo/desno	levo/desno	levo/desno	levo/desno	levo/desno
Tehničke karakteristike					
Materijal kazana	visokolegirani nerđajući čelik Č.4580 (prohrom)				
Radni pritisak (MPa)	0,6				
Izmenjivač (m ²)	0,3	0,3	0,3	0,5	0,5
Mg zaštitna anoda	da				
Toplotna izolacija	Mineralna vuna sa aluminijumskom folijom				
Debljina izolacije	50 mm				
Raspon temp. regulacije	do 85° C				
Termostat	Regulacioni i zaštitni				
Signalno svetlo	da				
Sigurnosni ventil	da				
Broj zidnih nosača	2 kom				
Stepen zaštite	IP 24				
Električne karakteristike					
Snaga grejača (W)	2000				
Radni napon (V)	230				

TALAS EB/KB/KSB

ELEKTRIČNI AKUMULACIONI ZAGREVAČ VODE
zatvorenog tipa serije TALAS EB/KB/KSB

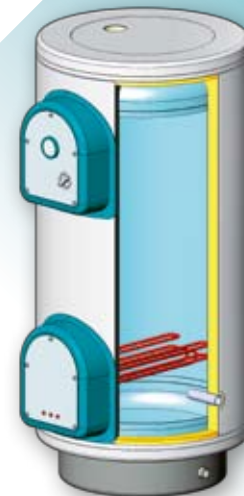
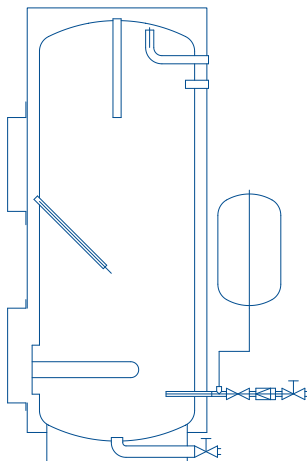
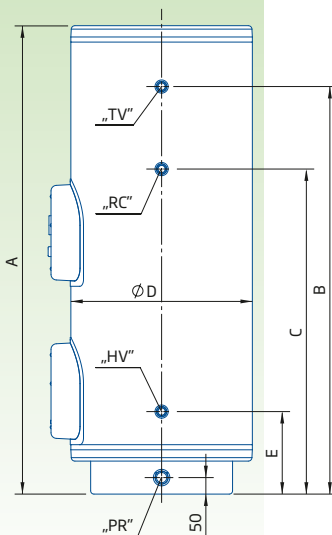

TIP EB

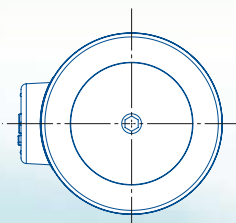

Tip	EB			
Oznaka	150	200	250	300
Zapremina (l)	150	200	250	300
Priključne mere				
A (mm)	1150	1320	1420	1670
B (mm)	790	1135	1235	1485
C (mm)	665	935	985	1235
D (mm)	500	550	550	550
E (mm)	230	250	250	250
Priključci				
HV (hladna voda)	G 3/4" muf			
TV (topla voda)	G 3/4" muf			
PR (pražnjenje)	G 1" muf			
RC (recirkulacija)	G 3/4" muf			
Tehničke karakteristike				
Materijal kazana	visokolegirani nerđajući čelik Č.4580 (prohrom)			
Radni pritisak (MPa)	0,8			
Mg zaštitna anoda	da			
Toplotna izolacija	Mineralna vuna sa aluminijumskom folijom			
Debljina izolacije	50 mm			
Raspon temp. regulacije	do 85° C			
Termostat	Regulacioni i zaštitni			
Signalno svetlo	da			
Sigurnosni ventil	da			
Stepen zaštite	IP 24			
Električne karakteristike				
Snaga grejača (kW)	3,0/4,5	3,0/4,5	3,0/4,5/6,0	3,0/4,5/6,0
Radni napon (V)	3N~380			

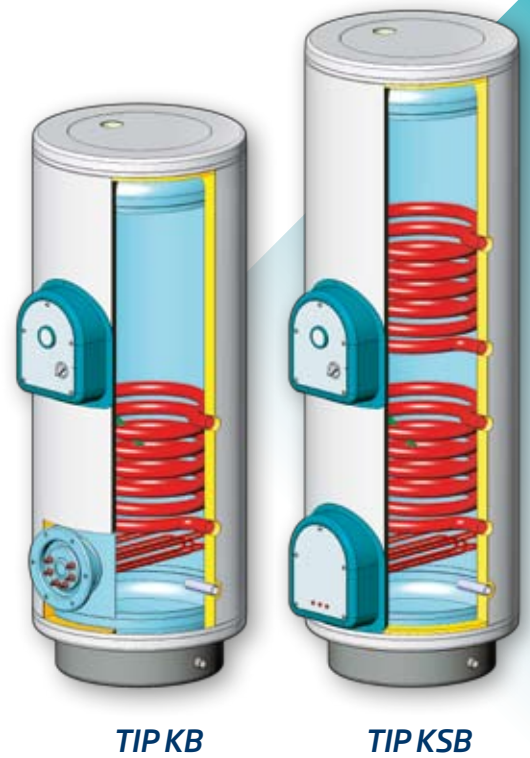
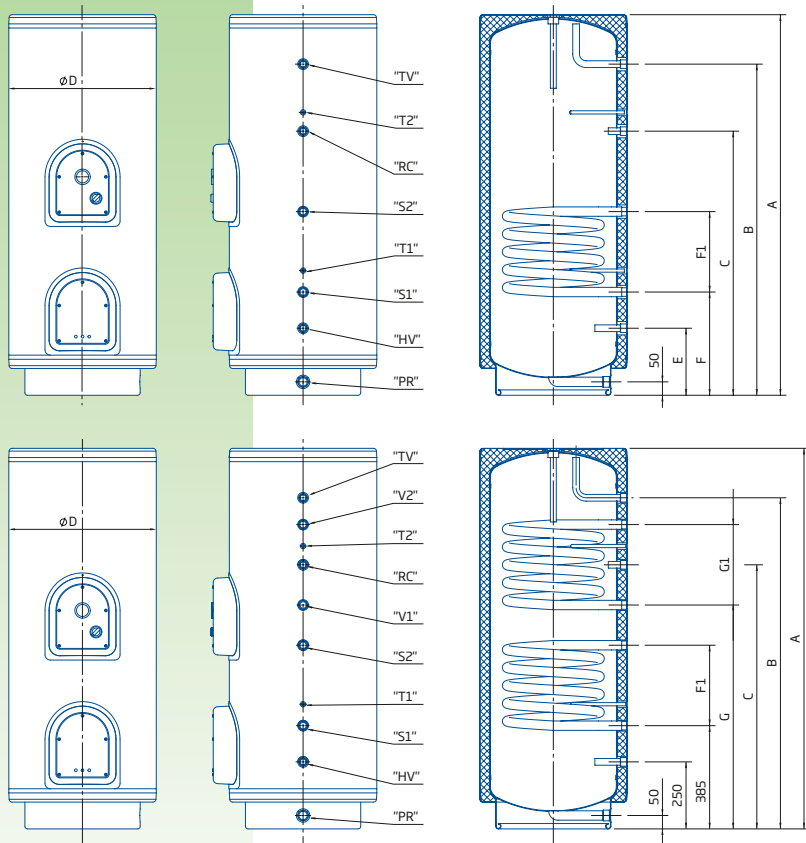

T1 i T2 - cevi za sonde unutrašnjeg otvora $\varnothing 10$

Tip	KB				KSB		
	150	200	250	300	200	250	300
Oznaka	150	200	250	300	200	250	300
Zapremina (l)	150	200	250	300	200	250	300
Priključne mere							
A (mm)	1150	1320	1420	1670	1320	1420	1670
B (mm)	790	1135	1235	1485	1135	1235	1485
C (mm)	665	935	985	1235	935	985	1235
D (mm)	500	550	550	550	550	550	500
E (mm)	230	250	250	250			
F (mm)	365	385	385	385			
F1 (mm)	300	300	300	420	250	300	420
G (mm)					785	835	955
G1 (mm)					250	300	300
Priključci							
HV (hladna voda)					G 3/4" muf		
TV (topla voda)					G 3/4" muf		
PR (pražnjenje)					G 1" muf		
RC (recirkulacija)					G 3/4" muf		
S1, S2 (izmenjivač donji)					G 3/4" muf		
V1, V2 (izmenjivač gornji)					G 3/4" muf		
Tehničke karakteristike							
Materijal kazana	visokolegirani nerđajući čelik Č.4580 (prohrom)						
Radni pritisak (MPa)	0,8						
Izmenjivač donji S (m²)	0,6	0,7	0,7	0,9	0,7	0,7	0,9
Izmenjivač gornji V (m²)					0,7	0,7	0,7
Mg zaštitna anoda	da						
Toplotna izolacija	Mineralna vuna sa aluminijumskom folijom						
Debljina izolacije	50 mm						
Raspon temp. regulacije	do 85° C						
Termostat	Regulacioni i zaštitni						
Signalno svetlo	da						
Sigurnosni ventil	da						
Stepen zaštite	IP 24						
Električne karakteristike							
Snaga grejača (kW)	4,5 / 6						
Radni napon (V)	3N-380						

Posude

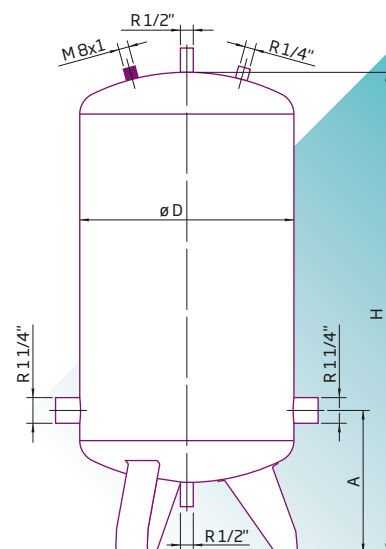
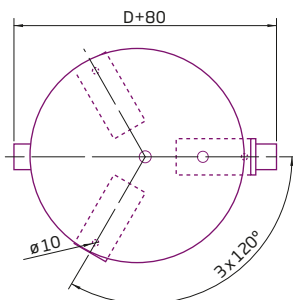

Zapremina V5% (l)	D (mm)	A (mm)	H (mm)
60	350	245	800
80	350	245	980
100	380	260	1050
120	380	260	1320
170	425	260	1280
200	425	260	1550
200	475	280	1350
250	475	280	1600
300	475	280	1850



Hidropak tip 2

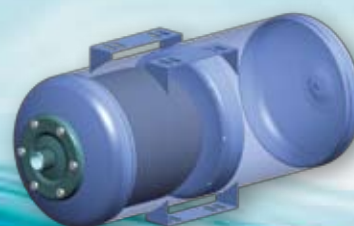

Hidropak tip 1

Električni grejač GT

ELEKTRIČNI GREJAČ sa elektronskim termostatom

Grejač sa elektronskim termostatom tip GT je uređaj koji se koristi za zagrevanje sistema kao što su: radijatori za kupatila, sušaći peškira ili kao dodatni element postojećih sistema radijatorskog grejanja. Može se koristiti i za druga grejna tela i uređaje.

Prednosti:

Izrađen od visokokvalitetnih komponenti,
Mogućnost fine regulacije temperature,
Jednostavno pozicioniranje dugmeta za regulaciju temperature u vidno polje,
Signalna lampica vidi se iz svih uglova,
Sigurnosno dihtovanje između radijatora i uređaja,
Termičkim osiguračima potpuno zaštićen od eventualnog pregrevanja.



Tip	GT 150	GT 300	GT 600	GT 900	GT 1200	GT 1500	GT 2000
Napon (V)	230						
Snaga grejača (W)	150	300	600	900	1200	1500	2000
Regulacija temperature	5 - 75°C ± 3°C						
Priključni kabl (1,3 m dužine)	OMY 3x0,75				OMY 3x1		
Frekvencija (Hz)	50						
Termička zaštita	94°C						
Mehanički priključak	G ½"						
Klasa izolacije	I						
Masa (g)	355	365	390	416	440	456	488
Dužina, L (mm)	295	312	360	410	460	505	605

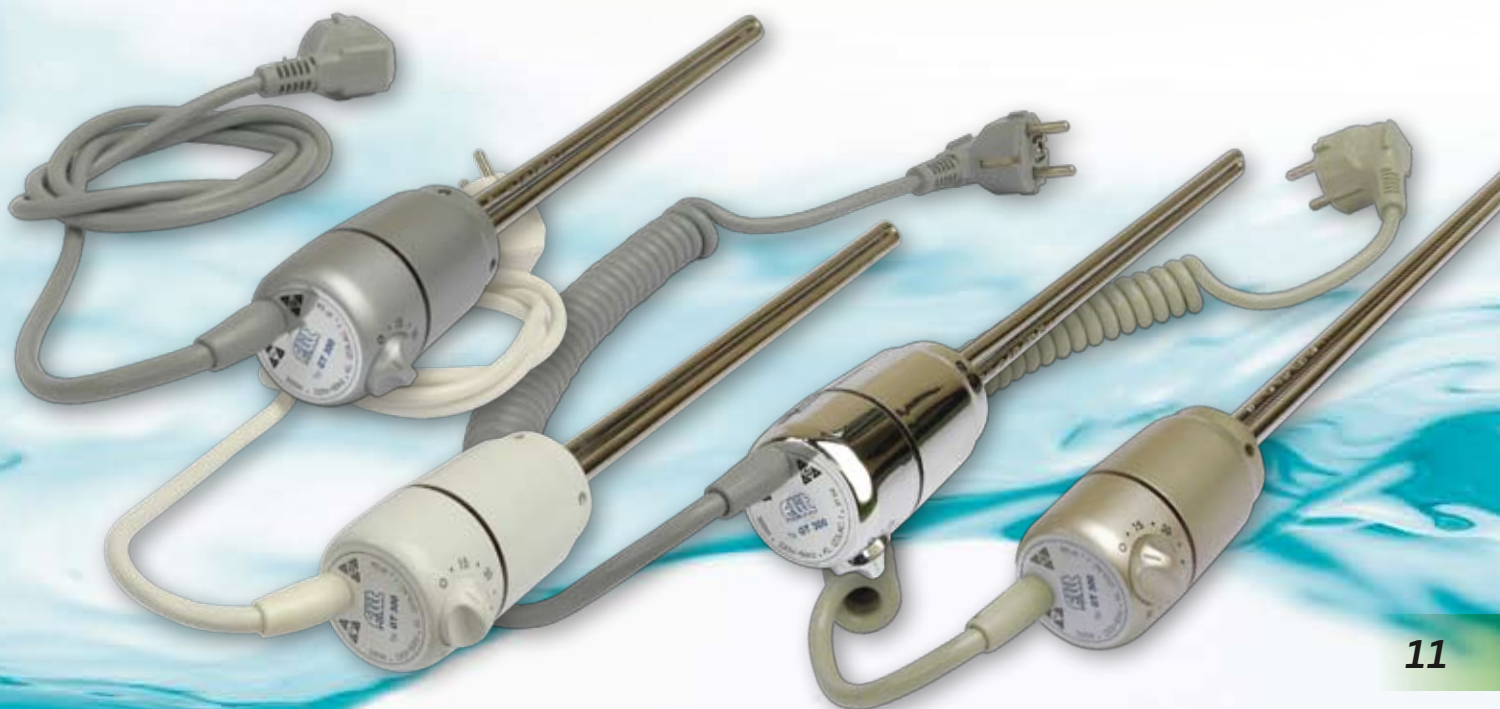

ELIT
inox



„Elit inox“ doo, Čačak • Skadarska br. 1 • 32000 Čačak
Tel: +381 32 589 251, 589 444 • Fax: +381 32 589 437
E-mail: elit@yu1.net • www.elitinox.co.rs